



Wireless Rain Gauge with Indoor / Outdoor Thermometer Model: RGR126 User Manual

CONTENTS

Introduction	2
Product Overview	2
Front View	2
Back View	3
LCD Display	4
Rain Gauge (PCR122)	4
Remote Thermo Sensor (THN122N)	5
Getting Started	6
Main Unit	6
Rain Gauge (PCR122)	6
Thermo Sensor (THN122N)	7
Data Transmission	9
Low Battery Warning	9
Clock / Calendar Setting	9
Set Clock & Calendar	9
Rainfall	10
Rainfall History	10
Total Rainfall	10
Rainfall Alarm	10

1

Temperature	11
Outdoor	11
Indoor	11
Reset	11
Precautions	11
Technical Specifications	12
Notices	12
Statement of Responsibility	12
About Oregon Scientific	13
FCC Statement	13
Declaration of Conformity	14

INTRODUCTION

Congratulations on purchasing the Oregon Scientific™ Wireless Rain Gauge with Indoor / Outdoor Thermometer (RGR126). The rain gauge is equipped with the following functions:

- Daily and total rainfall display
- 9-day rainfall history
- Rainfall alarm
- Indoor / outdoor temperature display
- Real-time clock and calendar setting
- 328-foot (100-meter) transmission range

The RGR126 operates at 433MHz. No wire installation is required.

PRODUCT OVERVIEW

FRONT VIEW

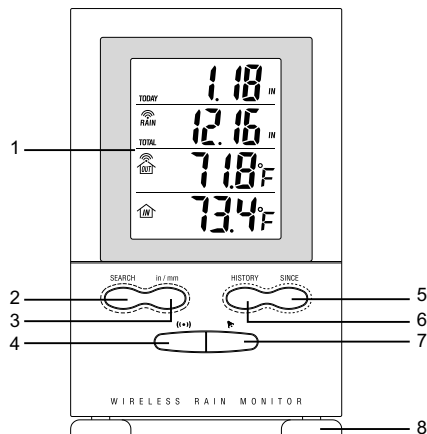

1. **FOUR-LINE LCD DISPLAY:** For displaying the total rainfall, current rainfall or rainfall history, indoor / outdoor temperature and clock / calendar
2. **SEARCH:** Press and hold to enforce a search for the rain gauge and remote thermo sensor
3. **in - mm:** Selects between inch and millimeter rainfall measurement



4. ((.)): Displays the rain alarm setting; press and hold to enter the rain alarm setting mode
5. **SINCE**: Toggles between displaying the start day or start year for total rainfall; press and hold to clear the previous rainfall start time and reset the rainfall counter to start again
6. **HISTORY**: Toggles between rainfall history and daily rainfall
7.  : Enables or disables the rainfall alarm
8. **REMOVABLE TABLE STAND**: For securing the main unit on a flat surface

1. **ANTENNA**: Receives radio signal from rain gauge and remote thermo sensor
2. **▲** : Increases setting values; press and hold for rapid increase
3. **▼** : Decreases setting values; press and hold for rapid decrease
4. **WALL MOUNT HOLE**
5. **TIME / SET**: Toggles among the time, day, year and rainfall display; press and hold to enter the time setting mode
6. **RESET**: Returns all settings to their default values
7. **°C / °F BUTTON**: Selects between °C and °F
8. **BATTERY COMPARTMENT**: Accommodates 2 x UM-3 or AA-sized batteries

BACK VIEW

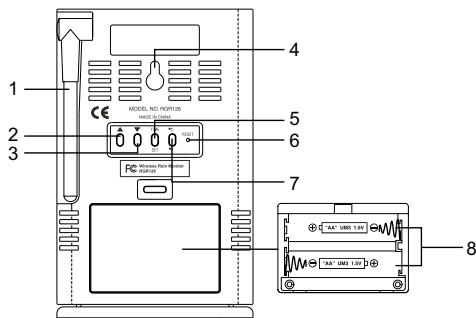

3

LCD DISPLAY

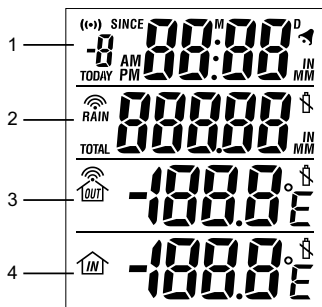

1. Today's Rainfall, Rainfall History, Rainfall Alarm, Start Date of Total Rainfall Record, Time / Date
2. Rain Gauge RF Reception Status, Total Rainfall
3. Thermo-sensor RF Reception Status, Outdoor Temp
4. Indoor Temp

RAIN GAUGE (PCR122)

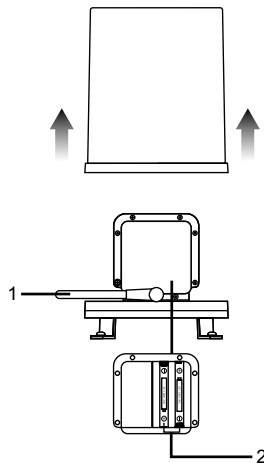

1. **ANTENNA:**
Transmits radio signal to main unit
2. **BATTERY COMPARTMENT:**
Accommodates 2 x UM-3 or AA-sized batteries



EN

REMOTE THERMO SENSOR (THN122N)

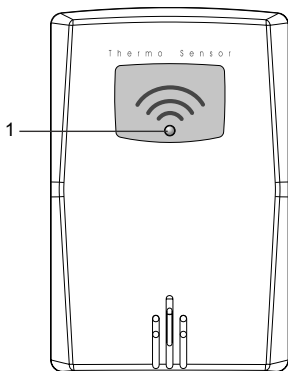

1. LED Indicator

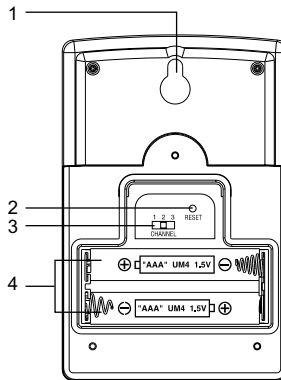

- 1. **WALL MOUNT HOLE**
- 2. **RESET hole**
- 3. **CHANNEL number (1-3)**
- 4. **BATTERY COMPARTMENT**

GETTING STARTED

Position the main unit, rain gauge, and thermo sensor within effective range:

- Rain gauge - 328 feet / 100 meters
- Thermo sensor - 98 feet / 30 meters

IMPORTANT It is recommended that you follow the sequence below when setting up the units:

1. Set up the main unit.
2. Set up the rain gauge, then press and hold **SEARCH** on the main unit and wait until you receive a signal.
3. Set up the thermo sensor, then press and hold **SEARCH** on the main unit and wait until you receive a signal.
4. In the event that you do not obtain a signal from a remote unit please repeat the process above.

MAIN UNIT

1. Insert the batteries, matching the polarity (+ and -) as shown in the battery compartment.

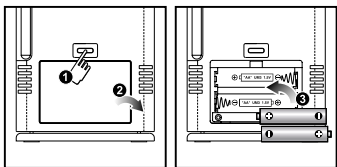

2. Press **RESET**, or press and hold **SEARCH** on the main unit to initiate operation. The reception icon on the main unit will blink while it is searching for the sensor or rainfall gauge.

NOTE Every time the battery in the main unit is changed, repeat installation before use.

RAIN GAUGE (PCR122)

1. Insert the batteries, matching the polarity (+ and -) as shown in the battery compartment.

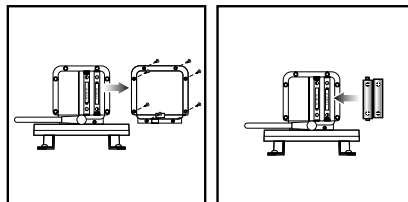

2. Mount the rain gauge on a level surface.



- Put drops of water on the cross at the base to check the leveling.

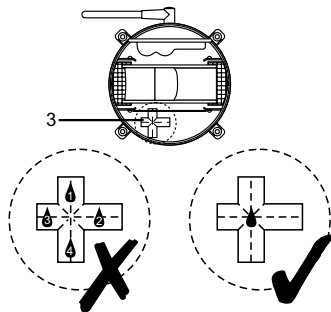

- Use the metal ring to adjust the level of the rain gauge.

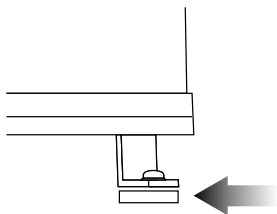

- Remove the fiber tape from around the bucket assemblies.



THERMO SENSOR (THN122N)

- Insert the batteries, matching the polarity (+ and -) as shown in the battery compartment.

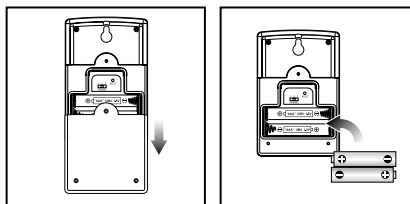

- Set the channel switch to any channel. The switch is located in the battery compartment.
- Press **RESET** on the sensor.
- Close the remote sensor battery compartment.

5. Secure the sensor in the desired location using the wall mount or table stand.

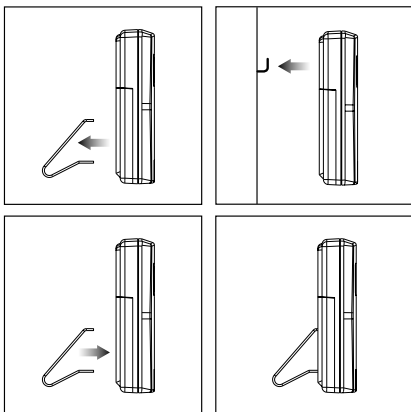

For best results:

- Insert the batteries before you mount the sensor.
 - Place the sensor out of direct sunlight and moisture.
 - Do not place the sensor more than 98 feet (30 meters) from the main (indoor) unit.
 - Position the sensor so that it faces the main (indoor) unit, minimizing obstructions such as doors, walls, and furniture.
- Place the sensor in a location with a clear view to the sky, away from metallic or electronic objects.
 - Position the sensor close to the main unit during cold winter months as below-freezing temperatures may affect battery performance and signal transmission.

You may need to experiment with various locations to get the best results.

Standard Alkaline batteries contain significant amounts of water. Because of this they will freeze in low temperatures of approximately 10°F (-12°C). Disposable Lithium batteries have a much lower threshold for temperature with an estimated freezing range of below -40°F (-40°C).

Wireless ranges can be impacted by a variety of factors such as extremely cold temperatures. Extreme cold may temporarily reduce the effective range between the sensor and the base station. If the unit's performance fails due to low temperature, the unit will resume proper functioning as the temperature rises to within the normal temperature range (i.e. no permanent damage will occur to the unit due to low temperatures).



DATA TRANSMISSION

Data is sent from the remote thermo sensor approx. every 78 seconds and every 94 seconds from the rain gauge. The reception icon shows the status - see table.

THERMO SENSOR	RAIN GAUGE	DESCRIPTION
		Searching
		Connected
		Disconnected

If without obvious reason the main unit display shows that the thermo sensor or rainfall connector is disconnected, press and hold **SEARCH** to enforce an immediate search.**N**

If that fails, check:

- The remote rain gauge and thermo sensor are still in place.
- The batteries of the main unit, rain gauge, and thermo sensor are still good. Replace them if necessary.
- The transmission is within range and path is clear of obstacles and interference. Shorten the distance if necessary. Then press and hold **SEARCH** again.

LOW BATTERY WARNING

There are 3 low-battery indicators - see table.

UNIT	LOCATION ON MAIN UNIT DISPLAY
Main	Indoor Temperature Area
Remote Thermo Sensor	Outdoor Temperature Area
Rain Gauge	Total Rainfall Area

Replace the batteries immediately when the respective indicator lights up.

CLOCK / CALENDAR SETTING

Press **TIME / SET** to toggle among today's rainfall, time, date, and year.

SET CLOCK & CALENDAR

1. Press **TIME / SET** to display the clock or calendar.
2. Press and hold **TIME / SET** for two seconds.
3. Use **▲** or **▼** to set the desired value.
4. Press **TIME / SET** to confirm.
5. Repeat steps 3 and 4 to complete all settings.
6. The order of the settings is hour, minute, year, month and day.

RAINFALL

Today's rainfall appears on the 1st line of the display and total rainfall is shown on the 2nd line. Press **in** / **mm** to toggle between inches and millimeters as the unit of measurement.

RAINFALL HISTORY

The rainfall history is displayed on the 1st line of the LCD display. The main unit can record up to 9 days of rainfall.

Use **HISTORY** to display the record for a particular day. The day of the record will be displayed with a minus (-) sign.

Caution: Other sensors using the 433 MHz transmission frequency may influence the rainfall reading. Please avoid placing those sensors too close to the unit.

TOTAL RAINFALL

The total rainfall is displayed on the 2nd line of the LCD display.

To display the commencing date of the total rainfall record, press **SINCE**. The date will appear on the 1st line of the display. Press again to show the commencing year.

To clear the existing commencing date and reset it to start again, press and hold **SINCE**. The total rainfall will now be equal to the today rainfall and the unit will start again to collect the rainfall data.

RAINFALL ALARM

The rain alarm value can be displayed at any time by pressing ((•)).

To set the rainfall alarm,

1. Press and hold ((•)) for two seconds.
2. Use ▲ or ▼ to set the desired value.
3. Press ((•)) to confirm. The alarm will be activated. The rain alarm indicator will light up.

The alarm will go off for one minute when the rainfall reaches the preset value and the rain alarm indicator will flash. A reminder beep will be emitted every minute. Once the rain alarm is on the indicator will not stop flashing unless **▶** is pressed or the rain alarm value is changed. To stop the alarm and reminder beep, press any button or change the rainfall alarm value.

To deactivate the alarm, press **▶**.



TEMPERATURE

OUTDOOR

The outdoor temperature is displayed on the 3rd line of the LCD display. Use the °C / °F button to select between Centigrade and Fahrenheit display units.

INDOOR

The indoor temperature is displayed on the 4th line of the LCD display. Use the °C / °F button to select between Centigrade and Fahrenheit display units.

RESET

This button should only be used when the unit is operating in an unfavorable way. Use a blunt stylus to hold down the button. All settings will return to their default values.

PRECAUTIONS

This product is engineered to give you years of satisfactory service if you handle it carefully. Here are a few precautions:

- Do not immerse the unit in water.
- Do not clean the unit with abrasive or corrosive materials. They may scratch the plastic parts and corrode the electronic circuit.
- Do not subject the unit to excessive force, shock, dust, temperature or humidity, which may result in malfunction, shorter electronic life span, damaged battery and distorted parts.
- Do not tamper with the unit's internal components. Doing so will invalidate the warranty on the unit and may cause unnecessary damage. The unit contains no user-serviceable parts.
- Only use fresh batteries as specified in the user's manual. Do not mix new and old batteries as the old ones may leak.
- Always read the user's manual thoroughly before operating the unit.

TECHNICAL SPECIFICATIONS

TYPE	DESCRIPTION
Main Unit Dimensions	
L x W x H	3.54 x 0.98 x 5.59 inches (90 x 25 x 142 mm)
Weight (without battery)	0.38 lbs (173 g)
Main unit	
Display rainfall range (total)	0 - 999.99 inch (0 - 25,400 mm)
Display rainfall range (history / daily)	0 - 99.99 inch (0 - 2,540 mm)
Rainfall resolution	0.04 inch (1 mm)
Operating range	23°F to 122°F (-5°C to +50°C)
Temperature resolution	0.2°F to (0.1°C)
Remote Rain Gauge (PCR122)	
Operating range	33.8° F to 140.0°F (1.0° C to 60.0°C)
Weight	0.57 lbs (260 g)
Remote Thermo Sensor (THN122N)	
Proposed operating range	-22° F to 140°F (-30° C to 60°C)
Power	
Main unit	2 x UM-3 / AA 1.5V batteries
Rain gauge	2 x UM-3 / AA 1.5V batteries
Remote thermo sensor	2 x UM-4 / AAA 1.5V batteries

General

RF Transmission Frequency	433 MHz
RF Transmission Range	Rain gauge - 328 feet (100 meters) Remote thermo sensor - 98 feet (30 meters)
Temperature sensing cycle	Around 78 seconds
Rainfall sensing cycle	Around 94 seconds

NOTE It is recommended that you use alkaline batteries with this product for longer performance or lithium batteries in temperatures below freezing.

NOTE Design and specifications are subject to change without notice.

NOTICES

STATEMENT OF RESPONSIBILITY

Oregon Scientific will not be held liable for any bodily injury, death, property damages, or any other claims of whatever nature resulting from the misuse or negligence of the product, whether intentional or unintentional.

Oregon Scientific will not be responsible for any deviations in the usage of the device from those specified in the user instructions or any approved alternations or repairs of the product.



ABOUT OREGON SCIENTIFIC

Visit our website (www.oregonscientific.com) to learn more about Oregon Scientific products such as digital cameras; MP3 players; children's electronic learning products and games; projection clocks; health and fitness gear; weather stations; and digital and conference phones. The website also includes contact information for our Customer Care department in case you need to reach us, as well as frequently asked questions and customer downloads.

We hope you will find all the information you need on our website, however if you're in the US and would like to contact the Oregon Scientific Customer Care department directly, please visit:

www2.oregonscientific.com/service/support

OR

Call 1-800-853-8883.

For international inquiries, please visit:

www2.oregonscientific.com/about/international/default.asp

FCC STATEMENT

This device complies with Part 15 of the FCC Rules. Operation is subject to the following two conditions: (1) This device may not cause harmful interference, and (2) This device must accept any interference received, including interference that may cause undesired operation.

WARNING Changes or modifications not expressly approved by the party responsible for compliance could void the user's authority to operate the equipment.

NOTE This equipment has been tested and found to comply with the limits for a Class B digital device, pursuant to Part 15 of the FCC Rules. These limits are designed to provide reasonable protection against harmful interference in a residential installation.

This equipment generates, uses and can radiate radio frequency energy and, if not installed and used in accordance with the instructions, may cause harmful interference to radio communications. However, there is no guarantee that interference will not occur in a particular installation. If this equipment does cause harmful interference to radio or television reception, which can be determined by turning the equipment off and on, the user is encouraged to try to correct the interference by one or more of the following measures:

- Reorient or relocate the receiving antenna.
- Increase the separation between the equipment and receiver.
- Connect the equipment into an outlet on a circuit different from that to which the receiver is connected.
- Consult the dealer or an experienced radio / TV technician for help.

DECLARATION OF CONFORMITY

The following information is not to be used as contact for support or sales. Please call our customer service number (listed on our website at www.oregonscientific.com), or on the warranty card for this product) for all inquiries instead.

We

Name: Oregon Scientific, Inc.
Address: 19861 SW 95th Ave., Tualatin,
Oregon 97062 USA
Telephone No.: 1-800-853-8883
Fax No.: 1-503-684-3332

declare that the product

Product No.: RGR126
Product Name: Wireless Rain Monitor
Manufacturer: IDT Technology Limited

Address: Block C, 9/F, Kaiser Estate,
Phase 1, 41 Man Yue St.,
Hung Hom, Kowloon,
Hong Kong

is in conformity with Part 15 of the FCC Rules. Operation is subject to the following two conditions: 1) This device may not cause harmful interference. 2) This device must accept any interference received, including interference that may cause undesired operation.