



# WeatherHawk™

## *Site Installation Guide*



*This Guide applies to both the Signature Series  
and Series 500 WeatherHawk System Families*

**WeatherHawk™**

815 W. 1800 N. Logan Utah 84321-1784, Email: [service@weatherhawk.com](mailto:service@weatherhawk.com)

Toll free in USA: 866-670-5982, International: 435-750-1802, FAX: 435-750-1749



# Table of Contents

<b><i>Power Sources</i></b> .....	1
<b><i>Site Selection</i></b>	
Ground Installations .....	1
Roof Installations .....	2
<b><i>Communications Considerations</i></b>	
Direct Communications	
Cable Lengths.....	2
Grounding Issues .....	2
Wireless Communications	
Transmission Ranges .....	3
Line-of-Sight .....	3
Testing Radio Transmissions .....	4
<b><i>Installation Procedures</i></b>	
Procedure 1: TP1 Tripod Installation Procedures	
Procedure 1a: Tripod Preparation for Installation .....	4
Procedure 1b: Ground Installations .....	6
Procedure 1c: Flat Roof Installations .....	7
Procedure 1d: Peaked Roof Installations .....	8
Procedure 2: TP1-GK Guy-Wire Kit Installation .....	9
Procedure 3: Mounting a WeatherHawk Station on a Tripod or Pole .....	10
Procedure 4: Solar Panel Installation .....	13
Procedure 5: TP1-GR Ground Kit Installation .....	14
<b><i>Appendix A: WeatherHawk Equipment</i></b>	
Communications Options	
USB-AD Serial-to-USB Adapter .....	15
RS485-KT Communications Module Kit.....	15
Power Supplies	
SP1-KT 1.6 W Solar Panel Kit.....	16
SP2-KT 5 W Solar Panel Kit.....	16
ACP1 AC Converter .....	16
Mounting/Installation Kits	
TP1—Tripod/Mast Assembly.....	17
TP1-TK—Tripod Installation Kit .....	17
TP1-SK—Tripod Stake Kit.....	17
TP1-MX—Tripod Mast Extension .....	18
TP1-GK—Tripod Guy-wire Kit .....	18
TP1-GR—Tripod Grounding Kit.....	18
HM Series (House Mount) Mast Components .....	19
<b><i>Customer Service &amp; International Service Centers</i></b> .....	20



## Site Installation Guide

This guide includes procedures for installing your WeatherHawk station on a tripod or pole, on the ground or a rooftop, and for installing our associated mounting/installation kits as required. Before installing your WeatherHawk at your site, read over the sections on power sources, site selection, and communications considerations. The installation procedures start on page 4.

### Power Sources

WeatherHawk weather stations are provided with an internal sealed rechargeable lead acid battery that must be recharged to assure continued system function. For recharging the battery, WeatherHawk offers solar panels or an AC/DC converter (see Appendix A: WeatherHawk Equipment). If no power supply has been ordered, you must provide an external DC power source that has an output of 18 V @ 1.2 amps.



Connecting an incompatible power source to your WeatherHawk voids your Warranty. Please check with WeatherHawk Customer Service before connecting a power source not purchased from WeatherHawk.

### Site Selection

#### *Ground Installations*

The ideal WeatherHawk site is level and well away from obstructions such as buildings, trees, and steep slopes. If obstructions exist, use the “Ten Times the Height Rule”, which is illustrated in Figure 1.

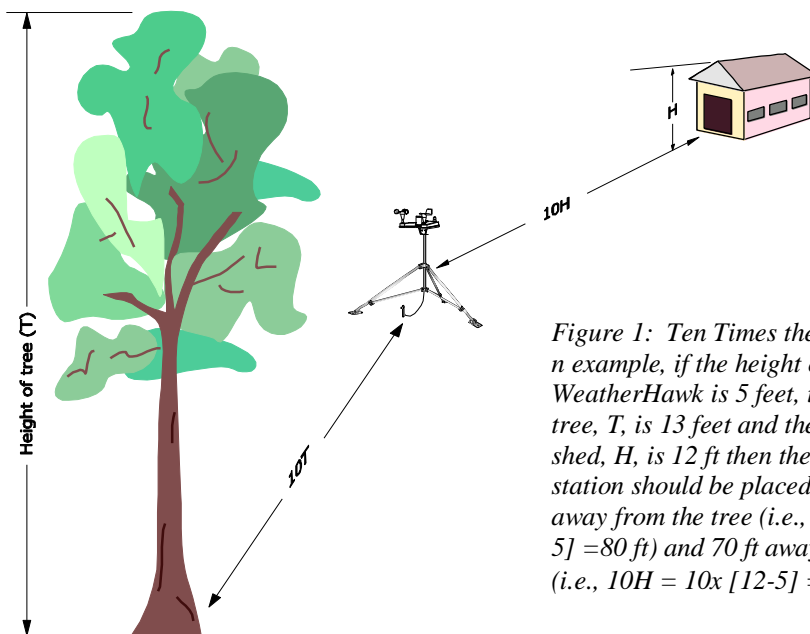

*Figure 1: Ten Times the Height Rule. In example, if the height of the WeatherHawk is 5 feet, the height of the tree, T, is 13 feet and the height of the shed, H, is 12 ft then the WeatherHawk station should be placed at least 80 ft away from the tree (i.e.,  $10T = 10 \times [13 - 5] = 80$  ft) and 70 ft away from the shed (i.e.,  $10H = 10 \times [12 - 5] = 70$  ft).*

An option when obstructions exist is to raise the weather station height above the obstruction by using mast extensions or mounting the WeatherHawk on a roof.



- 
- a. If your WeatherHawk station will be inside a fence to discourage vandalism, the fence top edge must be lower than the wind sensors even if the fence is chain-link.
  - b. Accurate wind measurements require your WeatherHawk to be located at the highest point in a particular region.
  - c. The TP1 tripod/mast height cannot exceed 10 feet (312 cm), and you must use a guy-wire kit if you increase the mast to the maximum height. If you need a higher mounting structure contact WeatherHawk for recommendations.
- 

## ***Roof Installations***

The WeatherHawk wind sensors need to be 4 - 8 feet (1.25 - 2.5 m) above the roof peak, which requires one or two extensions (TP1-MX) and a guy-wire kit (TP1-GK) when using the TP1 tripod and two extensions. If your roof has a chimney or is flat with a decorative trim, or has nearby trees taller than the house, follow the “Ten Times the Height Rule” described in Figure 1.



- 
- a. Do not install your WeatherHawk near a functional chimney. When the chimney is in use, the carbon particles in the soot may degrade and damage the bearings in the sensors. The heat may also affect the air temperature and relative humidity measurements.
  - b. Do not install your WeatherHawk on a mast or tripod with a television antenna, because the additional wind loading from the WeatherHawk may cause the antenna mast to fail and topple.
  - c. Because of electrical isolation and earth ground requirements, WeatherHawk recommends that a qualified electrician install and ground a directly connected roof mounted weather station. Your WeatherHawk Warranty is void if the weather station is not properly grounded.
- 

## **Communications Considerations**

### ***Direct Communications***

#### ***Cable Lengths***

If your cable length needs to be longer than 100 feet, use an MD485-KT Communications Module Kit and a user-supplied CAT 5 grade cable, or a StrikeGuard fiber optic modem kit.

#### ***Grounding Issues***

Outdoor cables may be subject to induced currents due to lightning or other environmental factors. Therefore proper grounding is imperative to avoid damage to the WeatherHawk and/or any connected Host device or computer.



---

To minimize the possibility of equipment damage or personal hazard, we strongly recommend a qualified electrician design and install the grounding and data isolation components of a directly wired installation.

---

## Wireless Communications

### Transmission Ranges

Site your WeatherHawk within the spread spectrum radio transmission range. Typical line-of-sight (LOS) transmission ranges are listed below:

- Up to ½ mile (0.8 km) for the WeatherHawk 916/922/520/521
- Up to ¼ mile (0.4 km) for the WeatherHawk 240
- Up to 7 miles if optional higher gain antennas are installed on both the WeatherHawk station and the RF4xx Base Station



- 
- a. The transmission ranges assume standard WeatherHawk antennas are used at the computer site. User-supplied, higher gain antennas at the base station and/or on the WeatherHawk can effect the transmission range.
- b. The ranges assume no obstructions are in the line-of-sight. Line-of-sight is defined and described below.
- 

### Line-of-Sight

Line-of-sight is defined as a straight path between a transmitting and receiving antenna that is unobstructed by intermediate topography or obstructions (see Figure 2). A clear line-of-sight is required to achieve the optimum transmission range. The affect of obstructions on the transmission range can vary. Therefore if obstructions lie within the line-of-sight, you should test your radio transmissions before permanently installing your WeatherHawk station (see Testing Radio Transmissions on next page).

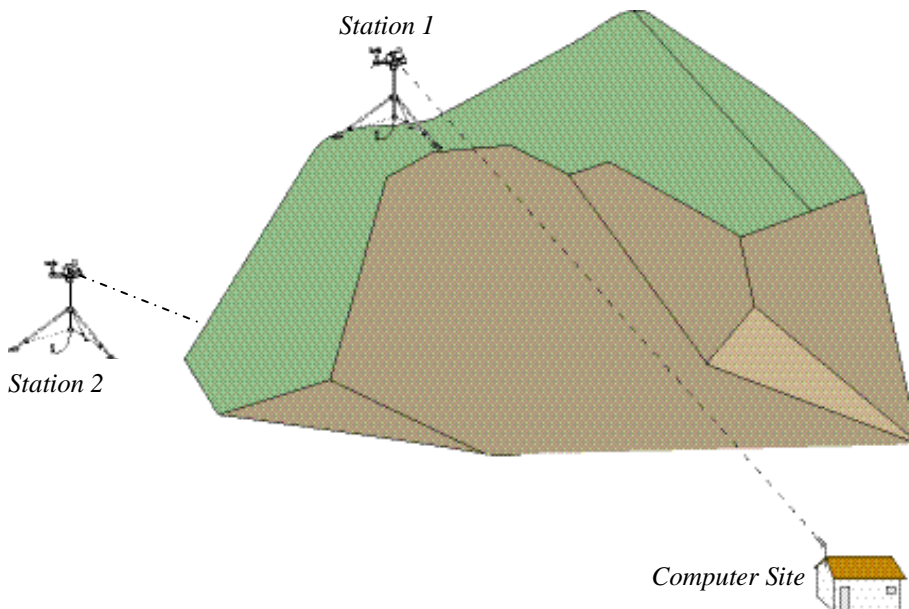

Figure 2: Line-of-sight examples. As the dotted line indicates, Station 1 has a clear line-of-sight with the Computer Site. The mountain obstructs Station 2's line-of-sight and would attenuate the RF signal or prevent wireless communications completely.

## ***Testing Radio Transmissions***

To test the radio transmission of your WeatherHawk, carry the WeatherHawk to the site attached to the tripod or mounting pole then attempt to communicate with the WeatherHawk using the host computer.

If obstructions in the line of sight are preventing the WeatherHawk from communicating, try the following:

- Relocate your WeatherHawk away from obstructions.
- Remove the obstructions.
- Mount the computer base station antenna outside of the building by running the antenna cable through a window or cable run.
- Use a higher gain antenna (optional) at the computer site.
- Install a higher gain antenna (optional) on the roof of the computer site's building and align it above the obstructions.

In general, trees and foliage, or metal siding and roofing will dramatically absorb or reflect RF energy and reduce the direct transmission range of a WeatherHawk wireless system, while wood frame and brick buildings will have less of an effect. In many cases RF energy will find an indirect path by reflection from the weather station to the base location; however, over-the-horizon sites must use repeaters, or very tall antenna masts to create a clear line-of-sight.



If you experience problems with RF communications, you can contact WeatherHawk Customer Service. To allow us to effectively help you, please be prepared to describe, in detail, your installation and site conditions.

---

## **Installation Procedures**

Many installation configurations for the WeatherHawk are possible. This document describes standard installation configurations. For questions about installation configurations not described in this document, contact WeatherHawk Customer Service.

### ***TPI Tripod Installation Procedures***

#### ***Procedure 1a: Tripod Preparation for Installation***

1. Attach tripod feet to the legs of the tripod using the bolts and self-locking nuts provided (Figure 3).



*Figure 3: The TPI Tripod Kit includes the nut and bolt (left) used to attach each foot to the tripod.*

2. If using mast extension(s), drive the extension(s) into the mast by inserting the tapered end of the extension into the top of the mast and striking the extension top with a wooden block or mallet (Figure 4).

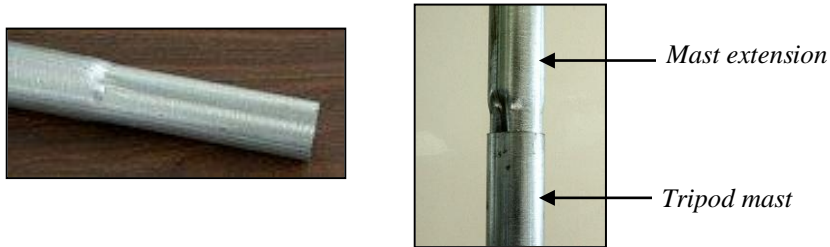

*Figure 4: Drive the tapered end of the mast extension (left) into the tripod mast. If using two extensions, drive the tapered end of the second extension into the top of the first extension.*



Do not use a metal hammer to drive in the mast extension since this will deform the top of the mast extension.

- 
3. If using the guy-wire kit (P/N TP1-GK), loosely install the guy-wire kit by following Procedure 2: TP1-GK Guy-wire Kit Installation (page 9).



Do not tighten the turnbuckles yet. The turnbuckles will be tightened in step 5 of Procedure 3: Mounting the WeatherHawk Station on a Tripod or Pole (page 11).

- 
4. Install the mast in the tripod and adjust mast height if necessary (Figure 5).

*Figure 5: The mast fits in the center of the tripod. The mast height is adjusted by moving the tripod legs or removing the mast cup and sliding the mast up or down in the collars.*

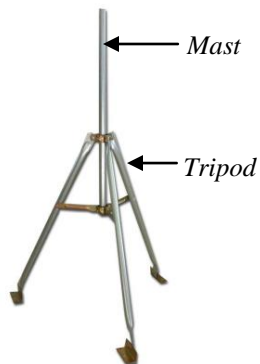

5. Once the mast height has been set, tighten all six collar bolts.
6. Install the tripod at the site. Refer to “Procedure 1b: Ground Installations” (p. 6), “Procedure 1c: Flat Roof Installations” (p. 7), or “Procedure 1d: Peaked Roof Installations” (p. 8).



### ***Procedure 1b: Ground Installations***

1. If needed, prepare the site. A temporary site may require brush or tall weeds to be removed and footings dug if the site is not level. A permanent site may require pouring a concrete pad or fabricating some other form of a permanent base (See WeatherHawk website for a hole pattern drawing of the TP1 to assist in pre-cast bolt alignment for permanent footings).
2. Use a rubber band to attach a level device, such as the one in the Tripod Installation Kit (P/N TP1-TK), to the midpoint of the tripod mast.
3. Place the tripod on the site.
4. Adjust tripod footings until the mast is level. Some adjustment is available by loosening/tightening the upper and lower collar bolts. If more adjustment is required, then for temporary sites, remove or replace soil under the TP1 feet. For permanent installations, use shims to adjust the foot foundation height.



For temporary sites, ensure the soil under the tripod feet is well compacted. Otherwise the tripod may not remain level after the tripod feet have been secured to the ground.

---

5. Secure the tripod feet to the ground (Figure 6).

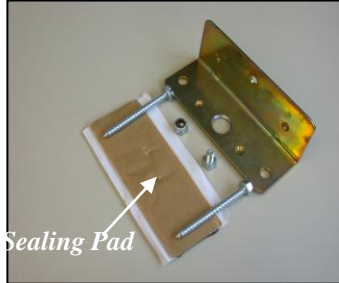

*Figure 6: For temporary sites, drive the stakes of the TP1-ST Kit (left) through the center hole in each tripod foot (right). The stakes should be driven in until they barely contact the foot surface. For permanent sites, install user-supplied bolts through the holes in each tripod foot.*

6. Follow Procedure 3: Mounting the WeatherHawk Station on a Tripod or Pole (page 10).

### ***Procedure 1c: Flat Roof Installations***

1. For each of the tripod feet, remove the protective paper from one side of the sealing pad to expose the adhesive then adhere the sealing pad to the bottom of the tripod foot (Figure 7).



*Figure 7: The sealing pads, as well as other hardware used to attach the tripod feet to a roof, are included in the TPI Tripod Kit. Either side of the sealing pad can be attached to the bottom of the tripod foot. Protective paper color may vary.*

2. Use a rubber band to attach a level device, such as the one in the Tripod Installation Kit (P/N TP1-TK), to the midpoint of the tripod mast.
3. Place the tripod on the roof, remove the protective paper from the bottom of the sealing pads, and extend the tripod legs.
4. Position the tripod such that it is level and all of the foot pads are flat on the roof. Some adjustment is available after the tripod has been attached to the roof by loosening/tightening the upper and lower collar bolts. If more adjustment is required, use shims to adjust the foot foundation height until the mast is level.
5. Screw the lag bolts through the holes of each tripod foot (Figure 8). The bolts must pierce the sealing pads.

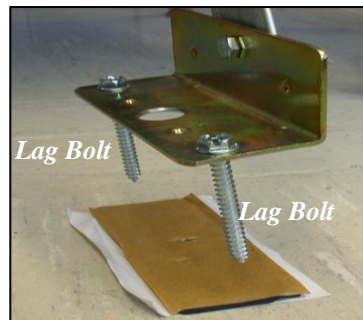

*Figure 8: The TPI Tripod Kit includes the lag bolts used to secure the TPI to a roof. Two lag bolts are used for each tripod foot. The bolts must pierce the sealing pads.*

6. Follow Procedure 3: Mounting the WeatherHawk Station on a Tripod or Pole (page 10).

## Procedure 1d: Peaked Roof Installations



The WeatherHawk wind sensors should be at least 8 feet (2.5 m) above the roof peak, which requires two extensions (TP1-MX) and a guy-wire kit (TP1-GK).

1. For each of the tripod feet, remove the protective paper from one side of the sealing pad to expose the adhesive then adhere the sealing pad to the bottom of the tripod foot (Figure 9).

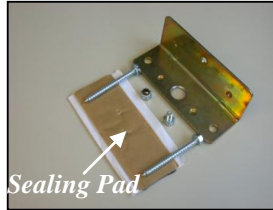

*Figure 9: The sealing pads, as well as other hardware used to attach the tripod feet to a roof, are included in the TP1 Tripod Kit. Either side of the sealing pad can be attached to the bottom of the tripod foot. Protective paper color may vary.*

2. Use a rubber band to attach a level device, such as the one in the Tripod Installation Kit (P/N TP1-TK), to the midpoint of the tripod mast.
3. Place the tripod at the peak of the roof with one foot pad on one side and two foot pads on the other side of the peak (Figure 10).

*Figure 10: Proper placement of the tripod on a peaked roof. When properly placed, all foot pads rest flat on the roof.*

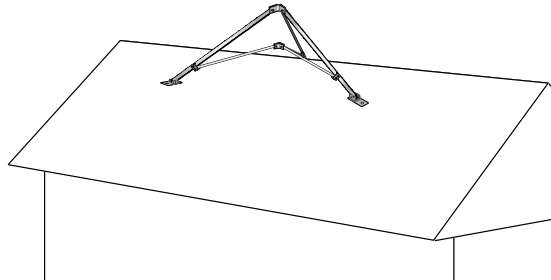

4. Remove the protective paper from the bottom of the sealing pads and extend the tripod legs.
5. Position the tripod such that it is level and all of the foot pads are flat on the roof. Some adjustment is available after the tripod is attached to the roof by loosening/tightening the upper and lower collar bolts. If more adjustment is required, make minor position changes in the tripod assembly until the mast is level.
6. Screw the lag bolts through the holes in each tripod foot and into the roof. (Figure 11).
7. Follow Procedure 3: Mounting the WeatherHawk Station on a Tripod or Pole (page 10).

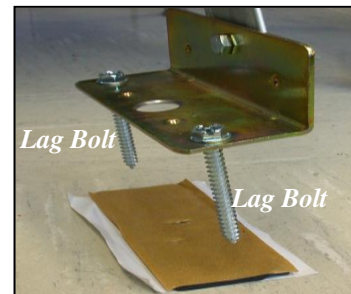

*Figure 11: The TP1 Tripod Kit includes the lag bolts used to secure the TP1 to a roof. Two lag bolts are used for each tripod foot. The bolts must pierce the sealing pads.*

## Procedure 2: TP1-GK Guy-Wire Kit Installation



1. Cut the guy-wire cable into three equal length pieces.
2. Loop one end of each guy-wire through a Bracket eye-bolt and clamp the guy-wire using one of the Clamps provided.
3. Install the Bracket on the tripod mast about six inches (15 cm) from the top of the mast then loosely tighten the bracket bolts that lock it to the mast.
4. Insert the mast into the Tripod and rotate the mast assembly until the bracket eye-bolts all line-up with a tripod leg then loosely tighten the mast collar bolts on the tripod.
5. Tighten the guy-wire Bracket bolts until they deform the mast by dimpling the surface to assure the Bracket does not slide when the turnbuckles are tightened.
6. Unscrew the turnbuckle until approximately 80% of both eye bolt threads extend beyond the turnbuckle body.
7. Hook an S-hook to an eyelet on each of the tripod feet. Alternatively, the S-hooks can be connected to user-supplied eye-bolts set into a concrete pad or another fixed structure.
8. One at a time, grasp a guy-wire and loop it around its corresponding S-hook to roughly determine its correct length then cut the guy-wires to eliminate any excess length.
9. Hook the unattached end of each S-hook to an eyebolt on the end of a turnbuckle.
10. Loop the free end of each guy-wire through its respective turnbuckle eye-bolt and pull it tightly then clamp the guy-wire using one of the Clamps provided.



- 
- a. The guy-wires need to remain loose until after the WeatherHawk assembly has been properly oriented. The turn-buckles are tightened in step 5 of Procedure 3: Mounting the WeatherHawk Station on a Tripod or Pole (page 11).
  - b. Guy-wires will stretch for a few weeks after installation. You should periodically check them for tension and re-tighten the turnbuckles as required until they stop stretching.
-

### ***Procedure 3a: Mounting a Series 500 Station on a Tripod or Pole***

---



This procedure assumes the WeatherHawk has been setup and tested at the computer location (see Quick Start Guide), and that a tripod or pole has been installed at the site (see TP1 Tripod Installation Procedures, pp 4-8).

---

1. Your WeatherHawk Series 500 has an integral mounting socket on the bottom, with a stainless steel strap clamp. This socket and clamp arrangement will accommodate mast sizes from 1.5-1.66 inches. The Series 500 is also supplied with a black rubber mast adapter. The mast adapter will adapt the weather station mounting socket for smaller mast sizes of 1.25 inches. Determine the outside diameter of the mast or pole. If it is 1.5-1.66 inches you will not use the mast adapter. If it is 1.25 inches you will slide the mast adapter over the mast, with the flange down. A light coating of detergent on the inside surface of the mast adapter will make installation easier.
2. Place your WeatherHawk weather station on top of the mast or pole with the socket seated on the top edge of the mast or pole. Loosely tighten the strap clamp screw so that the WeatherHawk is stable but can be rotated on the mast or pole.
3. As a reference, use a magnetic compass (supplied in the optional Tripod Installation Kit, P/N TP1-TK) and rotate the WeatherHawk assembly until the reference sticker on the side of the weather station is aligned with Magnetic North. If the sticker is missing you will find a North reference on the underside of the sensor section (upper half) of the weather station.
4. Firmly tighten the strap clamp screw.
5. If the TP1-GK Guy-wire Kit has been installed, assure that its orientation will not interfere with the solar panel (if one is installed) then evenly tighten the turnbuckles to tension the guy-wires.
6. Confirm the WeatherHawk is level by attaching a post level (supplied in the optional Tripod Installation Kit, P/N TP1-TK) to the mast and viewing the horizontal bubble level references. Minor adjustments can be made by tightening or loosening the appropriate guy-wire turnbuckle. Major adjustments may require a realignment of the entire mast assembly. It is critical that the top of the weather station is level to obtain accurate wind velocity and rainfall measurements.
7. Connect the power source that will recharge the internal sealed rechargeable battery. If using a solar panel, follow Procedure 4: Solar Panel Installation (page 12). If using an external power supply, you need to assure it is approved for use with the WeatherHawk weather station or that it has an output of 18VDC and that all connections are weatherproof.

---

a. The internal Sealed rechargeable battery must be recharged to assure continued system function.



b. Connecting an incompatible power source to your WeatherHawk negates your Warranty. Therefore WeatherHawk recommends you check with WeatherHawk Customer Service before connecting a power source not purchased from WeatherHawk.

c. WeatherHawk's ACPI AC Converter must be installed in a non-condensing environment or a weatherproof enclosure.

---

8. Remove and discard the green protective cap from the solar radiation sensor.
9. Turn the weather station power switch to the on position and return to the computer site to confirm the WeatherHawk is working properly.

### Procedure 3b: Mounting a Signature Series Station on a Tripod or Pole



This procedure assumes the WeatherHawk has been setup and tested at the computer location (see Quick Start-up Guide), and that a tripod or pole has been installed at the site (see TP1 Tripod Installation Procedures, pp 4-8).

1. Place your WeatherHawk assembly on top of the mast or pole with the base firmly seated on the top edge of the mast or pole (Figure 12).

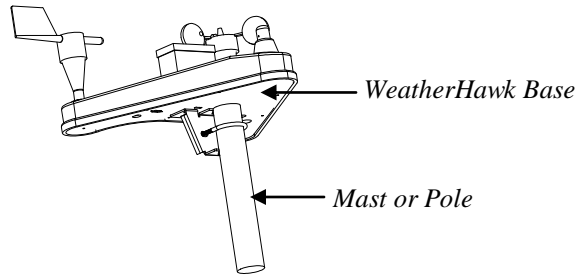

Figure 12: The WeatherHawk assembly properly seated on a mast or pole.

2. Loosely tighten the U-bolt nuts so that the WeatherHawk is stable but can be rotated on the mast or pole (Figure 13).

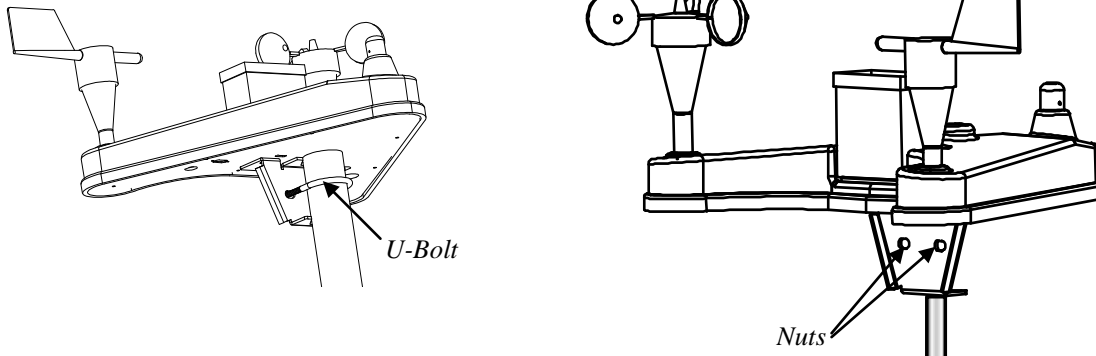

Figure 13: Two views of the WeatherHawk station. The U-bolt and nuts are shown.

3. As a reference, use a magnetic compass (supplied in the optional Tripod Installation Kit, P/N TP1-TK) and rotate the WeatherHawk assembly until the reference line on the wind direction sensor is aligned with Magnetic North (Figure 14).



Figure 14: Accurate wind direction measurements require the reference line on the wind direction sensor (right) to be aligned with Magnetic North.

4. Firmly tighten the U-bolt nuts.
5. If the TP1-GK Guy-wire Kit has been installed, assure that its orientation will not interfere with the solar panel (if one is installed) then evenly tighten the turnbuckles to tension the guy-wires.
6. Confirm the WeatherHawk is level by viewing the bubble level on top of the WeatherHawk (Figure 15). Minor adjustments can be made by tightening or loosening the appropriate guy-wire turnbuckle, placing shims between the WeatherHawk base and the top of the TP1 mast or pole, or loosening the mast bolts at the top and bottom of the TP1 tripod and shifting the vertical orientation.
7. Connect the power source that will recharge the internal sealed rechargeable battery. If using a solar panel, follow Procedure 4: Solar Panel Installation (page 12). If using an external power supply, you need to assure it was purchased from WeatherHawk for use with the WeatherHawk weather station or, if not purchased from WeatherHawk, that it has an output of 18 VDC and that all connections are weatherproof.



*Figure 15: The bubble level (in red box) confirms the station is level, which is required for accurate rainfall and solar radiation measurements.*

- 
- a. The internal Sealed rechargeable battery must be recharged to assure continued system function.
  - b. Connecting an incompatible power source to your WeatherHawk negates your Warranty. Therefore WeatherHawk recommends you check with WeatherHawk Customer Service before connecting a power source not purchased from WeatherHawk.
  - c. WeatherHawk's ACPI AC Converter must be installed in a non-condensing environment or a weatherproof enclosure.
- 



8. Remove and discard the red protective cap from the solar radiation sensor (Figure 16).



*Figure 16: A red or green cap (left) protects the solar radiation sensor (right) while the WeatherHawk is being shipped and installed. Accurate measurements require the cap to be*

9. Properly ground the WeatherHawk station. If using the TP1-GR Ground Kit, refer to Procedure 5: TP1-GR Ground Kit Installation (page 13).



- 
- a. The TP1-GR Ground Kit is for ground located installations only. Do not use the TP1-GR for rooftop installations.
  - b. Because proper grounding of the system is required for both personal safety and reliable system function, we recommend a qualified electrician install the grounding system.
- 

10. Turn the weather station key to the on position and return to the computer site to confirm the WeatherHawk is working properly.

## Procedure 4: Solar Panel Installation



1. Place the solar panel on the mast below the station to the maximum distance allowed by the solar panel cable.
2. Loosely tighten the U-bolt so that the solar panel is stable but can be rotated on the mast or pole.
3. Use a compass (supplied in the optional Tripod Installation Kit, P/N TP1-TK) to properly align the solar panel. If your site is in the northern hemisphere, the glass surface of the panel should face south. If your site is in the southern hemisphere, the glass surface of the panel should face north.
4. Connect the cable to the WeatherHawk connector labeled “Solar Panel”.



If you have a 5 W solar panel, this concludes the solar panel installation procedure. The remaining steps only apply to the 1.6 W solar panels. The 1.6 watt solar panel is only used with the WeatherHawk 232 weather station, it does not provide sufficient power for wireless WeatherHawk systems or for Series 500 WeatherHawk systems that have thermostatically controlled sensor heaters (Model 511/521).

5. In the mounting bracket of the 1.6 W Solar Panel, insert the screw in the hole associated with your site’s latitude (see table and labeled photo).

<i>Latitude (North &amp; South)</i>	<i>Hole #</i>	<i>Panel Angle</i>
Equator to 30°	1	30°
31° to 50°	2	50°
51° to 90°	3	70°

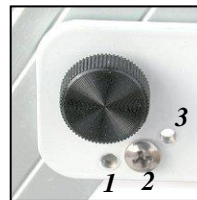

You should know the latitude of your site since latitude is a *Variable Setting* that was entered when setting up the station (see Quick Start Guide).

6. Tighten the thumb screws.



## Procedure 5: TP1-GR Ground Kit Installation

- a. Proper earth grounding of the system may be required for both personal safety and reliable system function, we recommend a qualified electrician install the grounding kit.



- b. If the station is directly connected to the Host computer but not properly grounded and isolated, the Host computer can be damaged by environmentally induced electrical surges.

- c. This kit is for ground installations only. Do not use the TP1-GR kit for rooftop installations. A qualified electrician should specify and install the earth ground system for a roof mounted weather station, if required.

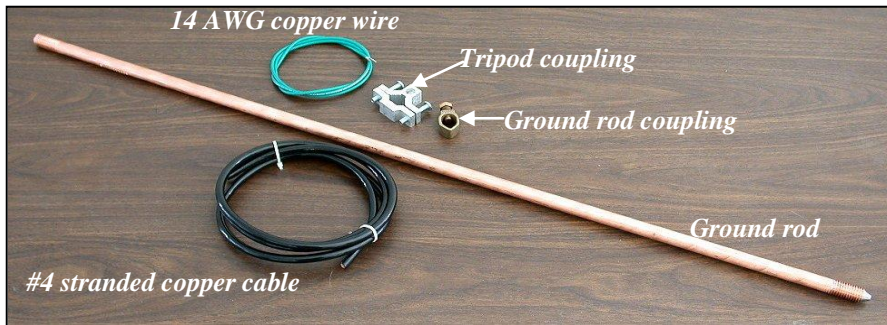

1. Connect the lug of the 14 AWG copper wire to the connector labeled Ground Lug on the bottom of the WeatherHawk station (Figure 17).

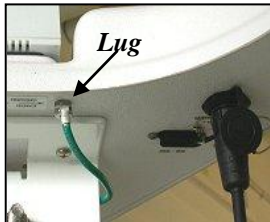

Figure 17: The ground lug connected to the bottom of the WeatherHawk.

2. Mount the tripod coupling on the tripod mast so that it clamps the 14 AWG wire against the tripod (1 of Figure 18).
3. Drive the ground rod into the soil using a fence post driver or sledge hammer leaving about 3 inches (7.5 cm) above the ground.
4. Loosen the middle screw in the tripod coupling.
5. Place one end of the #4 cable in the tripod coupling hole then tighten the screw (2 of Figure 18).
6. Attach the other end of the #4 cable to the ground rod using the ground rod coupling (Figure 19).

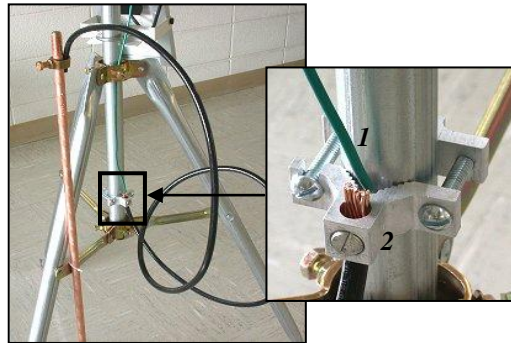

Figure 18: The TP1-GK assembly. Right is the 14 AWG wire and the #4 cable attached to the tripod coupling.



Figure 19: The #4 cable connected to the ground rod.

# Appendix A: WeatherHawk Equipment

The following equipment is available from WeatherHawk and these items can be ordered on-line at <http://www.weatherhawk.com>. Contact WeatherHawk Customer Service for questions concerning the use of the following equipment.

## Communications Options

### ***USB-AD Serial-to-USB Adapter***

The USB-AD Serial-to-USB Adapter is required if your computer has a USB port to communicate with the WeatherHawk. The USB-AD is a Universal Serial Bus (USB) converter that provides a plug and play RS-232 serial connection to a USB input on a computer. Data rates up to 230 kbps are supported.



The USB-AD includes:

- Universal Serial Bus (USB) Converter with a 1 meter cable
- Software (supports Windows 98/98SE/ME/2000/XP & Linux operating systems)
- Current software driver is on the WeatherHawk-XP/X software CD, or can be obtained from the OEM (FTDI Chip) at their website: <http://www.ftdichip.com>



This product is commercially produced and may not always be available in this specific configuration. WeatherHawk may substitute a part of equal or greater value if this device is discontinued by the manufacturer.

### ***RS485-KT Communications Module Kit***

The RS485-KT enables wired connections between the WeatherHawk 232 weather station and a Host computer (PC) for up to 4,000 feet (1300 meters). The customer must supply a CAT 5 cable, between the WeatherHawk and the Host computer, with each end terminating in RJ-11 connectors.

The RS485-KT includes:

- Opto-isolated RS485 interface module for the Host PC
- Power supply for the RS485 module located at the Host PC
- RS485 interface module for the WeatherHawk weather station



The RS485 module for the WeatherHawk is not weatherproof and must be installed in a non-condensing environment within 50 feet of the WeatherHawk station, or in a weatherproof enclosure at the WeatherHawk station.

## Power Supplies

### ***SP1-KT 1.6 W Solar Panel Kit***

This solar panel is for use with the WeatherHawk 232 only and when it is located below Latitude 40. It recharges the internal battery (see Procedure 4: Solar Panel Installation, p. 12). It has a 24 sq inch surface area and produces 1.6 watts, at a peak of 20 volts.



The SP1-KT includes:

- 1.6 W solar panel
- Mounting hardware



---

If your site Latitude is greater than 40°, and/or the site experiences extended periods of night, evening, or overcast skies, you should use the SP2-KT 5 W Solar Panel Kit instead of the SP1-KT. Contact WeatherHawk Customer Service if there are questions regarding the selection of the proper solar panel kit to use with your WeatherHawk.

---

### ***SP2-KT 5 W Solar Panel Kit***

This solar panel is for use with any WeatherHawk. It recharges the internal battery (see Procedure 4: Solar Panel Installation, p. 12). It has a 72 sq inch surface area and produces 5 watts, at a peak of 17.1 volts. This solar panel has a significantly greater output current than the SP1-KT solar panel.



The SP2-KT includes:

- 5 W solar panel
- Mounting hardware



---

This solar panel is recommended if your site Latitude is greater than 40°, and/or the site experiences extended periods of night, evening, or overcast skies. Contact WeatherHawk Customer Service if there are questions regarding the selection of the proper solar panel kit to use with your WeatherHawk.

---

### ***ACPI AC Converter***

The ACPI recharges the WeatherHawk battery by converting 110-220 VAC, 50/60 Hz power to 18 VDC. The ACPI must be installed in a non-condensing environment or a weatherproof enclosure.

The ACPI includes

- UL-approved, AC/DC converter with US Standard plug prongs
- 20 foot (6.2 meter), UV resistant waterproof cable with an environmental connector for connecting to the WeatherHawk



## Mounting/Installation Kits

### ***TP1—Tripod/Mast Assembly***

The TP1 tripod/mast assembly provides a stable support for the WeatherHawk and is suitable for both ground and rooftop installations (see TP1 installation procedures, pp 4-8).

The TP1 includes:

- Tripod
- Mast that places the WeatherHawk wind sensors at a height of 38” to 60” (99 to 156 cm)
- Kit that includes (3) tripod feet with hardware, (6) lag bolts (used for rooftop installations only), and (3) sealing pads (used for rooftop installations only)



### ***TP1-TK—Tripod Installation Kit***

This kit includes equipment that helps you install the WeatherHawk to the correct 3-axis vertical orientation and to align the station to the magnetic North (see TP1 installation procedures, pp 4-8). Using the TP1-TK to properly orient the weather station helps assure accurate measurements.

The TP1-TK includes:

- Multi-axis bubble level
- Compass
- Rubber band for attaching the bubble level to the tripod mast



### ***TP1-SK—Tripod Stake Kit***

The TP1-SK is for anchoring the tripod to the soil. It is intended for temporary installations and sites that experience light to moderate wind speeds (see TP1 Tripod: Ground Installation Procedure, p. 6).

The TP1-SK includes:

- (3) ½” (1.27 cm) diameter solid steel spikes with a welded hammer cap on one end



The above pictured stake kit may be replaced by three galvanized steel spikes that offer equal or better holding ability. Substitution is at the discretion of WeatherHawk based on product availability at the time of order.



Sites that may experience high wind speeds should not use this kit. For those sites, anchor the tripod with bolts and guy-wires fastened to a concrete pad or other permanent base.

---

### ***TP1-MX—Tripod Mast Extension***

The TP1-MX extension fits into a 1/4" diameter post and is used to increase the height of the WeatherHawk wind sensors (see TP1 installation procedures). When used with the TP1, one extension provides a wind sensor height of 69" to 89" (179 to 231 cm). A second TP1-MX can be used to provide a wind sensor height of 98" to 120" (255 to 312 cm).



The TP1-MX includes:

- 1/4" (32.5 cm) OD, 35" (89 cm) long steel post with one end crimped



- a. Do not use more than two TP1-MX extensions with the TP1 Tripod Assembly.
- b. When two TP1-MX extensions are used, the TP1-GK Guy-wire Kit is also recommended.

### ***TP1-GK—Tripod Guy-wire Kit***

The TP1-GK is used to increase the tripod's stability (see Procedure 3: Guy-wire Kit Installation, p. 9). It is intended for permanent installations, installations subject to consistently high wind speeds, or TP1 tripods using two mast extensions.



The TP1-GK includes:

- Plastic-coated, steel guy-wire cable
- Bracket for securing guy-wires to the TP1 mast
- (3) S-hooks
- (3) turnbuckles
- (6) clamps

### ***TP1-GR—Tripod Grounding Kit***

The TP1-GR provides hardware needed to properly ground the WeatherHawk and tripod. Properly grounding the station prevents electrical surges and lightning from damaging the WeatherHawk (see Procedure 5: TP1-GR Ground Kit Installation, p. 13).

The TP1-GR includes:

- 36" (91.4 cm) long copper sheathed steel electrical ground rod
- Electrical couplings for connection to the ground rod and tripod
- 5 ft length of plastic-coated, #4 stranded copper cable
- 3 ft length of 14 AWG stranded copper wire with a connection lug on one end



- a. Because proper grounding of the system is required for both personal safety and reliable system function, we recommend a qualified electrician install the grounding kit.
- b. If the station is not properly grounded, a computer connected to the WeatherHawk can also be damaged by electrical surges.
- c. This kit is for ground installations only. A qualified electrician should design and install the grounding system for a roof mounted station.

### ***HM1—Low Profile Mast Assembly***

The HM1/low profile mast assembly is a modified satellite dish mast. It provides a stable support for the WeatherHawk and is suitable for rooftop and well supported fascia board installations.

The HM1 includes:

- Foot
- Mast (12 inches 30.8 cm) high
- Kit that includes  
(6) lag bolts and (3) sealing pads (used for rooftop installations)



The HM3 is a three foot version of the HM1.

HM1, HM3 and HM-EXT components are provided with either a galvanized, polymer coating, or with a grey primer coating. Special order versions of these components can be provided in a range of colors using a thermally bonded powder coating process.

### ***HM-EXT—HM Series Mast Extension***

The HM3-EXT extension fits into the HM Series mast assembly and is used to increase the height of the WeatherHawk wind sensors.

The HM-EXT includes:

- One 35" (89 cm) long steel post with one end crimped



- a. Do not use more than two HM-EXT extensions with an HM Series Mast Assembly.
- b. When two HM-EXT extensions are used, the TP1-GK Guy-wire Kit is also recommended.



## Customer Service

Additional information is provided in “Frequently Asked Questions” on our Web site ([www.weatherhawk.com](http://www.weatherhawk.com)) or you can contact WeatherHawk at:

- 866-670-5982 (toll free in USA)
- 435-750-1802 (international)
- 435-750-1749 (FAX)
- [service@weatherhawk.com](mailto:service@weatherhawk.com)

## International Service Centers

### ***WeatherHawk (UK)***

United Kingdom and Europe

<http://weatherhawk.co.uk>

### ***Campbell Scientific of Canada***

Canada

<http://www.campbellsci.ca/CampbellScientific/splash.html>

### ***Campbell Scientific Australia***

Australia and regions in Asia

<http://www.campbellsci.com.au/>

### ***Campbell Scientific do Brasil Ltda.***

Brazil

email: [suporte@campbellsci.com.br](mailto:suporte@campbellsci.com.br)

### ***Campbell Scientific Africa***

Republic of South Africa and Sub-Saharan Africa

email: [sales@csafrica.co.za](mailto:sales@csafrica.co.za)

### ***Campbell Scientific Spain***

Spain

Email: [info@campbellsci.es](mailto:info@campbellsci.es)

